

**Please read and save these instructions. Read carefully before attempting to assemble, install, operate or maintain the product described. Protect yourself and others by observing all safety information. Failure to comply with instructions could result in personal injury and / or property damage! Retain instructions for future reference.**

# WELTEM ICEN

## Portable Air Conditioners

### Description

Weltem Portable Air Conditioners feature spot cooling for large areas where cooling of the entire area is not practical. A dedicated spot cooling thermostat controls the unit in this application. These air conditioners can also be used in smaller areas for room cooling. A control panel provides ease of use and contains a self-diagnostic function and display, showing operating modes, room and set temperatures, and faults. If an abnormal operation occurs, a visual display of the fault is shown. Caster wheels are included for easy portability. Suitable applications include: a factory or work place, industrial kitchen, computer room, emergency cooling, etc.



**WPC-15000**  
**Figure 1**

### Unpacking

After unpacking the unit, carefully inspect unit for any damage that may have occurred during transit. Check for any loose, missing, or damaged parts.

### Specifications

Model No.	Power Supply Ph-V-Hz	Cooling Capacity Btu/h	Power Consumption Watts	EER Btu/Wh
WPC-15000	3 phases, 380V, 50Hz	60,000	9200	13.2
Model No.	Nema Plug	Power Cord Gauge AWG	Power Cord Length m	Dimensions W x D x H . (mm)
WPC-15000	Terminal type	10	3	735 x 1310 x 1520
Model No.	Weight (Net / Gross) Lbs(kg)	No. of Cool Air Outlets Pcs	Condensate tank Gallons(Liters)	Ambient temperature range °F(°C)
WPC-15000	694 / 727 (315 / 330)	3	Auto Pump Included	64~113 (18~45)
Model No.	Setting temperature (Room cool mode) °F(°C)		Setting temperature (Spot cool mode) °F(°C)	
WPC-15000	64~86 (18~30)		32~86 (0~30)	

## Specifications (Continued)

Model No.	Application Area (Room cool mode) ft <sup>2</sup> (m <sup>2</sup> )	Refrigerant Type / oz(g)	Design Pressure - Hi/ Low Psig	
WPC-15000	1830 (170)	R-410A / 102.2 (2900)	465 / 250	
Model No.	Indoor Air Flow CFM(CMM)	Wheels pcs / diameter	Hot Air Duct Diam- eter In.(mm)	Maximum Duct Length ft(m)
WPC-15000	1900 (53)	4 / 127mm	20 (500)	100 (30)
Safety Devices		Compressor overload protector, Anti-freezing thermister, Full drain tank switch, Automatic restart (Power interruption), Compressor time delay program, High pressure switch		
Features		Temperature control, Self-diagnostic function, Two speed fan, Optional drain pump kit, Washable filters, °F(°C) display, Off-timer		

## General Safety Information

Please read this manual carefully for instructions on correct installation and usage. Please read all safeguards.

1. Transport and store the unit in an upright position only. Leave unit in an upright position for at least 3 hours before first use.
2. Always place the unit on an even, level surface.
3. Ensure the unit is connected to a grounded power supply of the correct rating / capacity.
4. The unit will cool when the room temperature is between 18°C (64.4°F) ~ 45°C(113°F) depending on the thermostat setting.
5. DO NOT use this unit for functions other than those described in this instruction manual.
6. DO NOT tilt the unit.
7. DO NOT cover or obstruct the unit's inlet and outlet grilles.
8. DO NOT use the unit in areas where it will be exposed to rain or water.
9. NEVER unplug the unit while it is operating.

**▲ WARNING** *DO NOT use the unit in wet environments, such as a laundry room, to avoid the risk of electrical shock.*

10. DO NOT place any foreign objects on the unit.
11. DO NOT operate the unit with wet or damp hands.
12. DO NOT allow chemical substances to come into contact with the unit.
13. DO NOT operate the unit in the presence of flammable substances or vapors such as alcohols, pesticides, gasoline, etc.

**▲ WARNING** *DO NOT operate the unit in explosive or flammable environments.*



14. DO NOT use the power cord to start and to stop the unit. Always use the control panel to start and to stop the unit.
15. Always turn off the unit when it is not in use and disconnect the power cord from the electrical outlet.
16. Always turn the unit off and disconnect the power cord from the electrical outlet before cleaning, moving or performing maintenance.
17. AVOID the use of extension cords. If it is necessary to use an extension cord to operate the unit, ensure that they are correctly rated for the application. Consult a local qualified electrician and all local electrical codes to ensure proper setup. Any extension cord used with this device must be rated for a minimum of 20A.
18. DO NOT disconnect the unit by pulling on the electrical cord. Keep electrical cord away from heat sources and always completely unroll the cord to avoid overheating. If the power cord becomes damaged, a qualified service agent, qualified electrician, or similarly qualified person must replace it, in order to avoid a hazard or shock.

**▲ WARNING** *DO NOT operate a unit with a damaged power cord.*

19. The filters must be used with the product at all times. When the filters are removed for cleaning, always ensure that the unit has been turned off and disconnected from the electrical outlet.
20. Regularly clean the filters to maintain efficiency. If the filters are not cleaned regularly, the units output performance and efficiency will decline and energy consumption will increase.
21. DO NOT operate the unit with a damaged power cord, after it malfunctions, has been dropped or damaged.
22. Only use in the upright position on an even, flat surface. Unit must be positioned at least 24 inches (60 cm) from the nearest object in any direction.
23. Stop operation immediately if abnormal noise or odor is noticed. Contact a local service center.
24. Appliance is not to be used by children or persons with reduced physical, sensory or mental capabilities, or lack of experience and knowledge, unless they have been given supervision or instruction.
25. Children being supervised not to play with appliance.
26. That the appliance shall be installed in accordance with national wiring regulations.
27. If the supply cord is damaged, it must be replaced by the manufacturer, its service agent or similarly qualified persons in order to avoid a hazard.

**SAVE THESE INSTRUCTIONS**

## Assembly COMPONENT PARTS

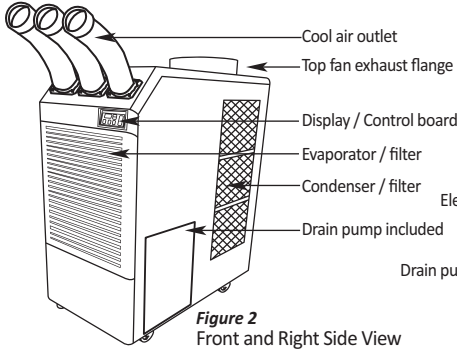

**Figure 2**  
Front and Right Side View

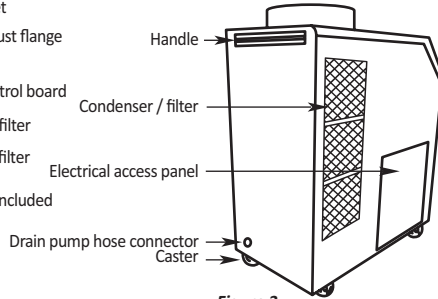

**Figure 3**  
Back and Left Side View

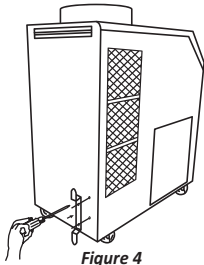

**Figure 4**

### POWER CORD HOLDER

1. Take out the cord holder from the accessory box.
2. Place the cord holder on the back side of air conditioner.
3. Use screws (enclosed inside of accessory box with cord holder) to install the cord holder on the air conditioner as shown in Figure 4.

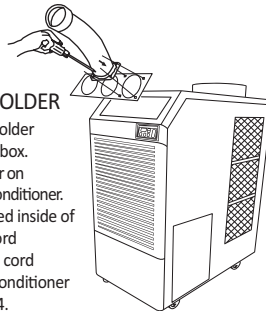

**Figure 5**

### DISCHARGE DUCTS /SUPPLY AIR DUCT

1. Remove cool air outlet hose(s) from carton.
2. Place the cool air outlet hose(s) on the front top of air conditioner.
3. Use screws (enclosed inside of box with cool air outlet hose(s)) to install the cool air outlet hose(s) on the air conditioner as shown in Figure 5.

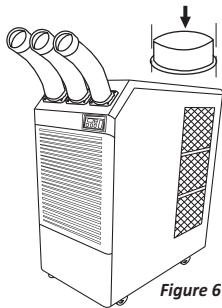

**Figure 6**

### TOP FAN EXHAUST FLANGE

1. Remove the top fan exhaust flange from carton.
2. Place the top fan exhaust flange on the top of air conditioner.
3. Use screws (enclosed inside of box with the top fan exhaust flange) to install the top fan exhaust flange on air conditioner as shown in Figure 5.



## Installation

### WARNINGS REGARDING PROPER LOCATION FOR INSTALLATION

**▲ WARNING**

*Do not use the unit in explosive environments or in areas where flammable gas leakage may occur.*

**▲ WARNING**

*Do not use the unit in areas where it will be exposed to rain or water.*

**▲ WARNING**

*Do not use the unit in a corrosive atmosphere.*

**▲ WARNING**

*Do not use the unit above 18°C(64°F) ~ 45°C(113°F).*

**▲ WARNING**

*Do not install the unit on uneven or sloping surface. The unit may roll or topple over even if the casters are set to the locked position.*

## MOVING THE UNIT

Unlock the casters and push the unit using the rear handle to a flat, level surface and set the caster brakes to the locked position.

## CONNECTING POWER TO THE UNIT

Check the prongs and surface of the power cord for dust/dirt. If dust and/or dirt are present, wipe off with a clean, dry cloth.

Check the power cord and prongs for damage or excess play.

If any damage or excess play is found, contact a qualified repair technician or a qualified electrician to perform replacement or repair of the power cord or prongs.

**▲ WARNING**

*If the power cord is damaged, repair should only be performed by qualified electrical personnel.*

**▲ WARNING**

*Do not connect / disconnect the power cord or attempt to operate buttons with wet hands. This could result in electrical shock.*

**NOTE:** Make sure the AC outlet is free of dirt, dust, oil, water, or any other foreign material.

## Operation

### CONTROL PANEL

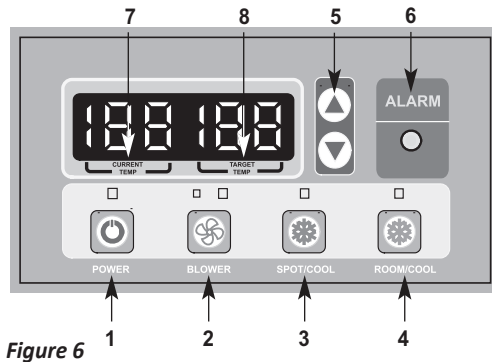

Figure 6

1. **POWER BUTTON:** Activates unit when POWER BUTTON is pressed. (Fan starts on low speed). If power button is pressed during operation, unit stops.
2. **BLOWER BUTTON:** Changes fan speed from (Low) to (High) when pressed.
3. **SPOT/COOL BUTTON:** Activates compressor and begins producing cool air 5 seconds after button is pressed. Regulates temperature based on outlet cool air temperature.
4. **ROOM/COOL BUTTON:** Activates compressor and produces cool air 5 seconds after button is pressed. Regulates temperature based on inlet ambient air temperature.
5. **SET TEMP BUTTONS:** Change target temperature/data value by +/- 1. Change data value by +/- 10 by pressing continually. Press the SET TEMP BUTTONS to set temperature. Upper button is to heighten temperature and Lower button is to lower temperature.
6. **ALARM:** Alarm indicator lights (blinks) and indicates abnormal system operation. If Alarm occurs, compressor stops. System operation stops when ALARM light is activated (blinks) longer than 3 minutes.
7. **CURRENT TEMP:** Displays current room temperature in display in Celsius. (In Room Cool Mode only). SPOT/COOL Mode – Displays outlet (cool air) temperature during normal operations. In order to change °C to °F, press SPOT/COOL and ROOM/COOL buttons together for 2 seconds. F will blink 2 times and Figure will change to °F. ALARM codes blink and are displayed when abnormal operation occurs.
8. **TARGET TEMP:** displays the unit set temperature for ROOM/COOL mode only.

**OFF-TIMER:** Enter to Timer Setting Mode if you press BLOWER Button and SPOT/COOL Button together for 1 seconds. Press UP/DOWN Button to set the timer until it shows the figure you want to set. After 5 seconds, the figure will be memorized and the compressor will stop after the time set.

**AUTO RESTART:** If the unit goes off due to an electrical interruption, the unit will automatically restart when the power resumes.

## Maintenance

### FILTER CLEANING *(See Figures 7 and 8)*

There are three filters in the unit. The evaporator filter is located at the front of the unit. The condenser filters are located at the side of the unit.

1. Loosen up 2 bolts on the front filter guard.
2. Slide filter up and use a vacuum cleaner to remove the dust from the filter.
3. If the filter is heavily covered with dust and dirt, warm water and mild soap or neutral detergent may be used to wash the filter. Do not use any other chemicals to clean filter, as they will likely damage the filter.
4. Dry the filter in a shaded area before replacing it. Do not operate the unit without the filter installed and the filter guard in the closed position.
5. Replace the clean filter and close the filter guard.
6. To clean the condenser filters, lift up on the side filters from the middle bar slightly and then angle the filters outwards from the bottom and remove.
7. Use the same cleaning procedure as above (3 – 5).
8. To replace the condenser filter, place the top of the filter in the guide and slide the filter up until the bottom of the filter clears the frame. Then push the bottom of filter into the guide and let filter gently fall inside the guide.

**NOTE:** For effective cooling clean the filter at least every 2 weeks.

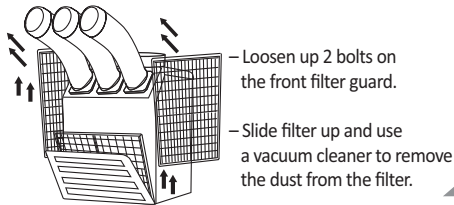

**Figure 7 – Removing Filters**

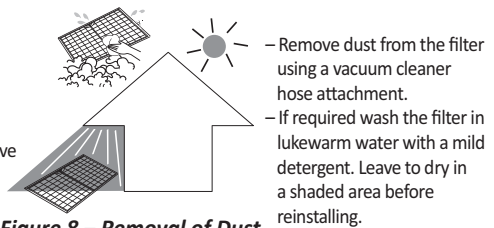

**Figure 8 – Removal of Dust**

**▲ WARNING** *Do not operate without the filter fitted.*

**▲ WARNING** *Do not operate the unit with a damaged cord or plug, after the unit malfunctions, or if the unit has been dropped or damaged.*

- For your convenience, record the complete model number and product name (located on the Product Identification Plate), the purchase date, purchase location, serial number, and warranty period in the table below.
- Also, attach your purchase receipt as proof of purchase to this instruction manual for future reference.
- To ensure your product is covered by warranty, the complete faulty product along with your original purchase receipt must be provided at the place of purchase.



## Maintenance *(Continued)*

– To ensure your product is covered by warranty, the complete faulty product along with your original purchase receipt must be provided at the place of purchase.

<b>Product</b>	<b>Portable Air Conditioner</b>
Model No.	_____
Date of Purchase	_____
Place of Purchase	_____
Serial No.	_____
Period of Warranty	_____

**Customer:** Please read and keep this manual for future reference and keep sales receipt as proof of purchase.

## SELF-DIAGNOSTIC CODES *(See Table 1)*

The alarm light is activated if abnormal operation occurs, and a code is displayed on the control panel. The compressor and condenser fan motor will stop operating. The evaporator fan will continue to run for 3 minutes. If the fault is rectified within 3 minutes, the unit will resume operation. If the fault persists for more than 3 minutes, the evaporator fan also stops. The fault must be rectified before the unit can resume normal operation.









SELF-DIAGNOSTIC ALARM CODES			
Alarm Display	Problem	Cause	Corrective Action
	Frost prevention sensor and Abnormal temperature sensor value	<ul style="list-style-type: none"> <li>Indoor heat exchanger temperature too low</li> <li>TH3 temperature sensor has a loose or broken connection</li> </ul>	<ul style="list-style-type: none"> <li>Do not use the air conditioner if ambient temperature is lower than 18°C (64°F)</li> <li>Contact a qualified service agent</li> </ul>
	Refrigerant high pressure switch	<ul style="list-style-type: none"> <li>Blocked air filter</li> <li>Blocked / kinked exhaust duct</li> <li>Ambient temperature is too high</li> </ul>	<ul style="list-style-type: none"> <li>Clean air filter</li> <li>Ensure exhaust duct is not blocked / kinked</li> <li>Do not use the air conditioner if ambient temperature is higher than 45°C (113°F)</li> </ul>
	Abnormal temperature sensor value	TH1(Outlet) temperature sensor has a loose or broken connection	Contact a qualified service agent
	Abnormal temperature sensor value	TH2(Inlet) temperature sensor has a loose or broken connection	Contact a qualified service agent
	Compressor overloaded	<ul style="list-style-type: none"> <li>Ambient temperature is too high</li> <li>Unstable voltage supply</li> <li>Defective compressor</li> <li>Defective evaporator motor (for wpc-1503)</li> <li>Defective condenser motor (for wpc-1503)</li> </ul>	<ul style="list-style-type: none"> <li>Do not use the air conditioner if ambient temperature is higher than 45°C (113°F)</li> <li>Contact a qualified service agent</li> <li>Replace compressor</li> <li>Contact a qualified service agent</li> </ul>
	Drain pump alarm	Drain pump defective or improper hose connection (including kink or blockage)	<ul style="list-style-type: none"> <li>Check the hose connection and hose</li> <li>Replace drain pump</li> </ul>

Table 1- Alarm Codes

# Wiring Diagram

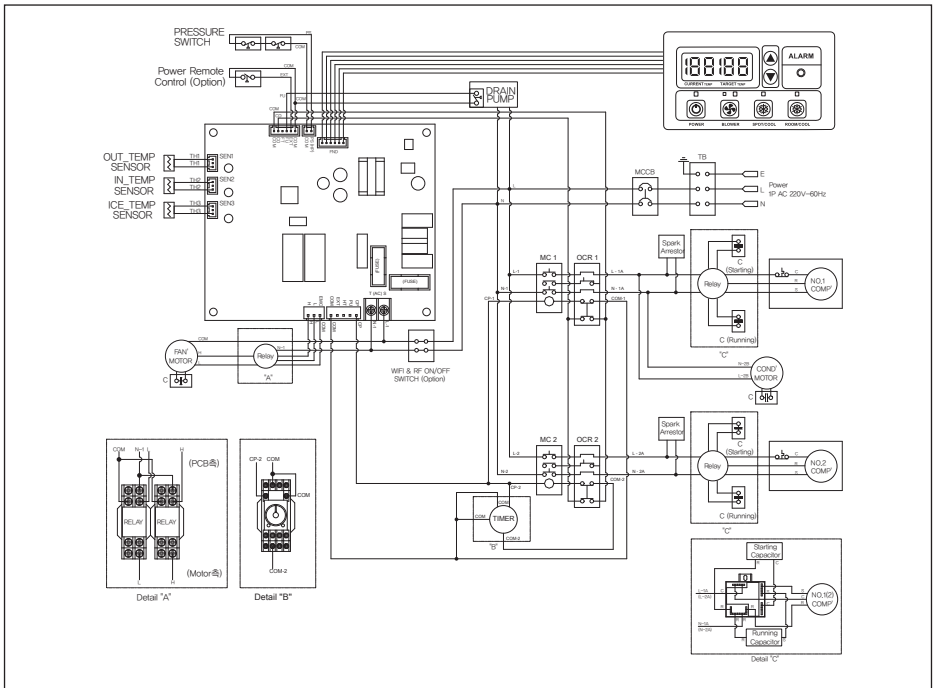

Figure 9 - Circuit Wiring Diagram

## Troubleshooting chart

Symptom	Possible Cause(s)	Corrective Action
Water leakage	High water level in condensate tank	<ol style="list-style-type: none"> <li>1. Remove blockage from drain hose</li> <li>2. Remove any object stuck underneath of the black panel under the water tank</li> </ol>
The unit doesn't work	<ol style="list-style-type: none"> <li>1. Check the power supply to verify that power is available to the unit</li> <li>2. Verify that the power cord is connected</li> </ol>	<ol style="list-style-type: none"> <li>1. Reset the circuit breaker and restart the unit</li> <li>2. Connect power cord</li> </ol>
No cold air flows from the cold air outlet	<ol style="list-style-type: none"> <li>1. Ambient air cannot be properly cooled if the filter is dirty and not regularly cleaned</li> <li>2. Compressor will not work if the unit is turned off and on quickly.</li> <li>3. The ambient air temperature may be too high</li> </ol>	<ol style="list-style-type: none"> <li>1. Clean the filter</li> <li>2. Wait 2 minutes after unit is turned off before turning the unit back on.</li> <li>3. The temperature of the compressor can be higher when the ambient temperature is too high. The compressor will not work unless the ambient air temperature is within the acceptable operating range of the unit</li> </ol>
Water flow can be heard after compressor shuts off	No cause	Common to hear coolant flowing after unit shuts off

**LIMITED WARRANTY**

**WELTEM ONE-YEAR LIMITED WARRANTY.** WELTEM PORTABLE AIR CONDITIONERS, MODELS COVERED IN THIS MANUAL, ARE WARRANTED BY WELTEM TO THE ORIGINAL USER AGAINST DEFECTS IN WORKMANSHIP OR MATERIALS UNDER NORMAL USE FOR ONE YEAR AFTER DATE OF PURCHASE. ANY PART WHICH IS DETERMINED TO BE DEFECTIVE IN MATERIAL OR WORKMANSHIP AND RETURNED TO AN AUTHORIZED SERVICE LOCATION, WELTEM DESIGNATES, SHIPPING COSTS PREPAID, WILL BE, AS THE EXCLUSIVE REMEDY, REPAIRED OR REPLACED BY WELTEM OPTION. FOR LIMITED WARRANTY CLAIM PROCEDURES, SEE "PROMPT DISPOSITION" BELOW. THIS LIMITED WARRANTY GIVE PURCHASERS SPECIFIC LEGAL RIGHTS WHICH VARY FROM JURISDICTION TO JURISDICTION.

**LIMITATION OF LIABILITY.** TO THE EXTENT ALLOWABLE UNDER APPLICABLE LAW, WELTEM LIABILITY FOR CONSEQUENTIAL AND INCIDENTAL DAMAGES IS EXPRESSLY DISCLAIMED. WELTEM LIABILITY IN ALL EVENTS IS LIMITED TO AND SHALL NOT EXCEED THE PURCHASE PRICE PAID.

**WARRANTY DISCLAIMER.** A DILIGENT EFFORT HAS BEEN MADE TO PROVIDE PRODUCT INFORMATION AND ILLUSTRATE THE PRODUCTS IN THIS LITERATURE ACCURATELY; HOWEVER, SUCH INFORMATION AND ILLUSTRATIONS ARE FOR THE SOLE PURPOSE OF IDENTIFICATION, AND DO NOT EXPRESS OR IMPLY A WARRANTY THAT THE PRODUCTS ARE MERCHANTABLE, OR FIT FOR PARTICULAR PURPOSE, OR THAT THE PRODUCTS WILL NECESSARILY CONFORM TO THE ILLUSTRATIONS OR DESCRIPTIONS. EXCEPT AS PROVIDED BELOW, NO WARRANTY OF AFFIRMATION OF FACT, EXPRESSED OR IMPLIED, OTHER THAN AS STATED IN THE "LIMITED WARRANTY" ABOVE IS MADE OR AUTHORIZED BY WELTEM.

**Technical Advice and Recommendations, Disclaimer.** Notwithstanding any past practice or dealings or trade custom, sales shall not include the furnishing of technical advice or assistance or system design. Weltem assumes no obligations or liability on account of any unauthorized recommendations, opinions or advice as to the choice, installation or use of products.

**Product Suitability.** Many jurisdictions have codes and regulations governing sales, construction, installation, and/or use of products for certain purposes, which may vary from those in neighboring areas. While attempts are made to assure that Weltem products comply with such codes, Weltem cannot guarantee compliance, and cannot be responsible for how the product is installed or used. Before purchase and use of a product, review the product applications, and all applicable national and local codes and regulations, and be sure that the product, installation, and use will comply with them.

Certain aspects of disclaimers are not applicable to consumer products; e.g., (a) some jurisdictions do not allow the exclusion or limitation of incidental or consequential damages, so the above limitation or exclusion may not apply to you; (b) also, some jurisdictions do not allow a limitation on how long an implied warranty lasts, consequently the above limitation may not apply to you; and (c) by law, during the period of this Limited Warranty, any implied warranties of implied merchantability or fitness for a particular purpose applicable to consumer products purchased by consumers, may not be excluded or otherwise disclaimed.

**Prompt Disposition.** A good faith effort will be made for prompt correction or other adjustment with the respect to any product which proves to be defective within limited warranty. For any product believed to be defective within limited warranty, first write or call dealer from whom the product was purchased. Dealer will give additional directions. If unable to resolve satisfactorily, write to Weltem at the address below, giving dealer's name, address, date, and number of dealer's invoice, and describing the nature of the defect. Title and risk of loss pass to buyer on delivery to common carrier. If product was damaged in transit to you, file claim with carrier.

Manufactured in Weltem co., Ltd., 154, Jayumuyeok 3-gil, Masanhoewon-gu, Changwon-City,  
Gyeongsangnam-do, 51340 Korea [www.weltem.com](http://www.weltem.com)

Printed in December, 2019